

sFoam™

Surfboard Blank Catalog-Supplement

Outlines

sFoam
222 West Broad Street
Freeport, TX 77541

sales 979-633-4324

March 13, 2009

New & Revised Styles

5' 2" G_t

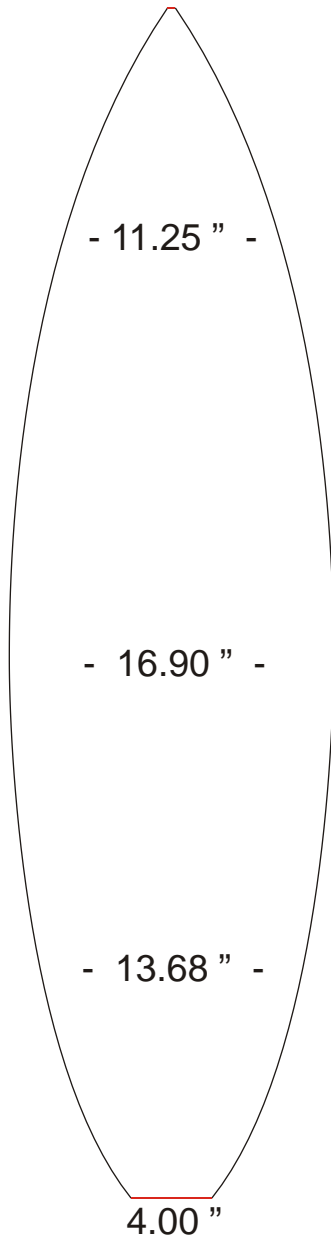

Tip-to-Tip Length : 5 ' 2 "

Maximum Width: 16.90 "

Comments: Grommet comet.
Maximum width at 3 " toward tail.

Width is measured at 12 " from nose, 12 " from tail and at the widest point.

Square tails and tails cut from square are also measured.

Please note:

All dimensions can be changed for a customized purpose-built blank!



www.sfoam.com

5' 6" TF_t

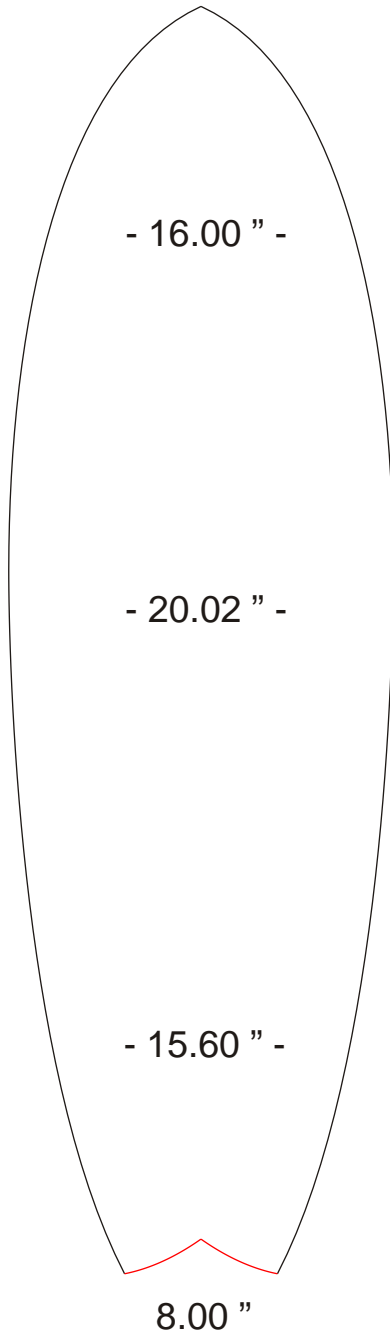

Tip-to-Tip Length : 5 ' 6 "

Maximum Thickness: 2.26 "

Comments: Maximum width at 3.70" from nose.

Width is measured at 12 " from nose, 12 " from tail and at the widest point.

Square tails and tails cut from square are also measured.

Please note:

All dimensions can be changed for a customized purpose-built blank!



www.sfoam.com

5' 9"TF_t

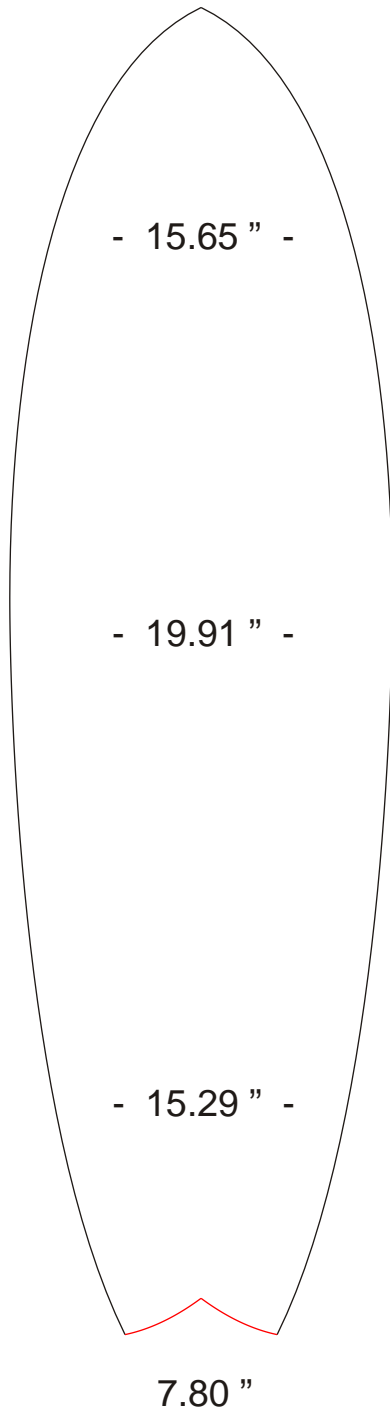

Tip-to-Tip Length : 5 ' 9 "

Maximum Thickness: 19.91 "

Comments: Maximum thickness at 3.84 towards nose.

Width is measured at 12 " from nose, 12 " from tail and at the widest point.

Square tails and tails cut from square are also measured.

Please note:

All dimensions can be changed for a customized purpose-built blank!



www.sfoam.com

6' 0" F_t

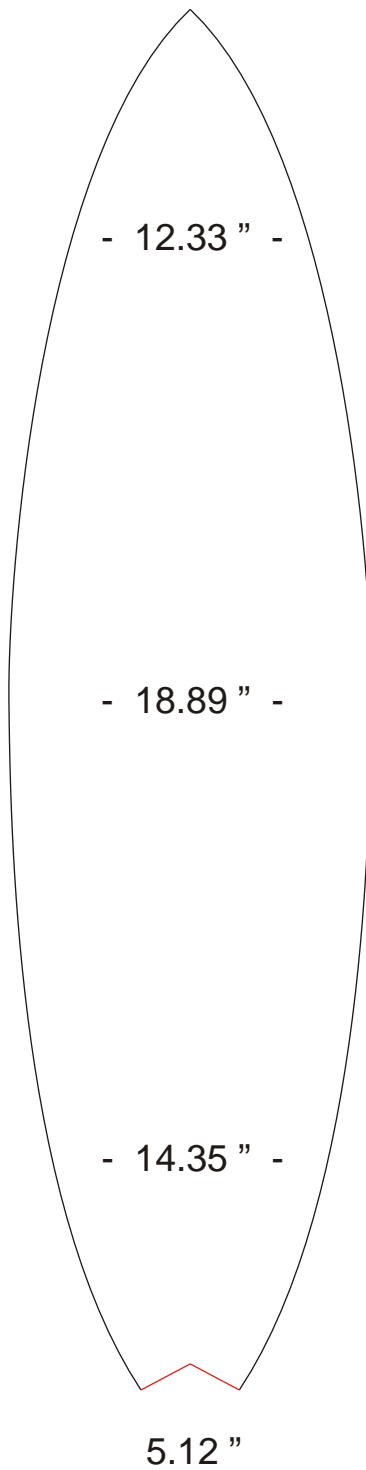

Tip-to-Tip Length : 6 ' 0 "

Maximum Thickness: 18.89 "

Comments: Modern Fish Thruster. Series 5 ' 10 " to 6 ' 8 " .

Width is measured at 12 " from nose, 12 " from tail and at the widest point.

Square tails and tails cut from square are also measured.

Please note:

All dimensions can be changed for a customized purpose-built blank!



www.sfoam.com

6' 0" RF_t

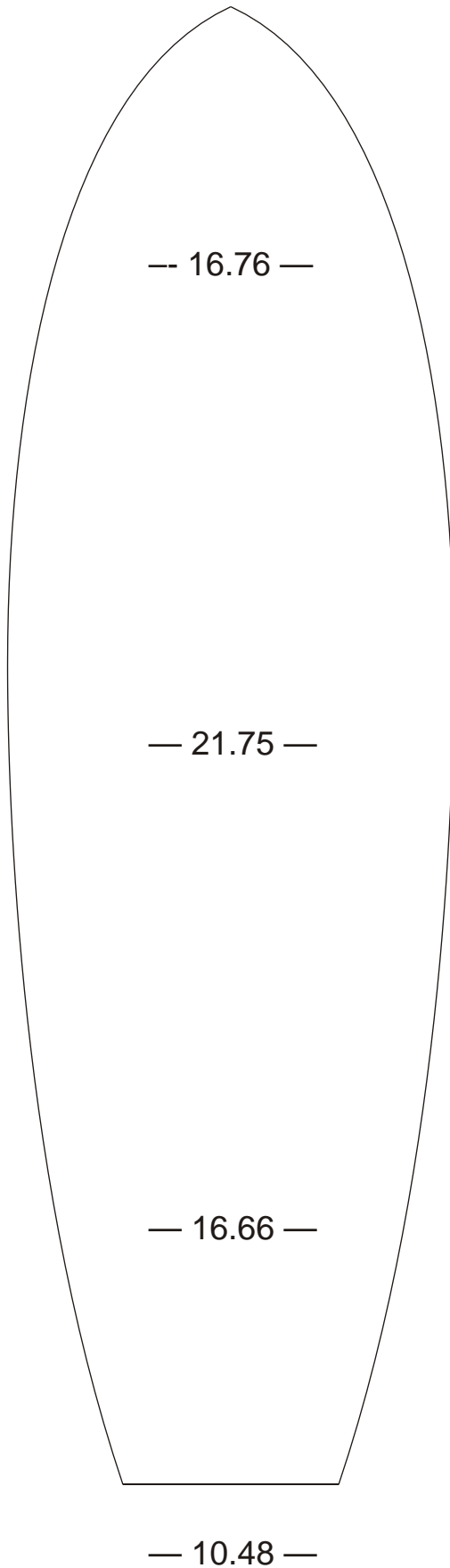

Tip-to-Tip Length : 6 ' 0 "

Maximum Width: 21.75 "

Comments:

Retro Fish, can be scaled to fit. Companion to 60RF rocker cut.

Width is measured at 12 " from nose, 12 " from tail and at the widest point.

Square tails and tails cut from square are also measured.

Please note:

All dimensions can be changed for a customized purpose-built blank!

6' 0" S_t

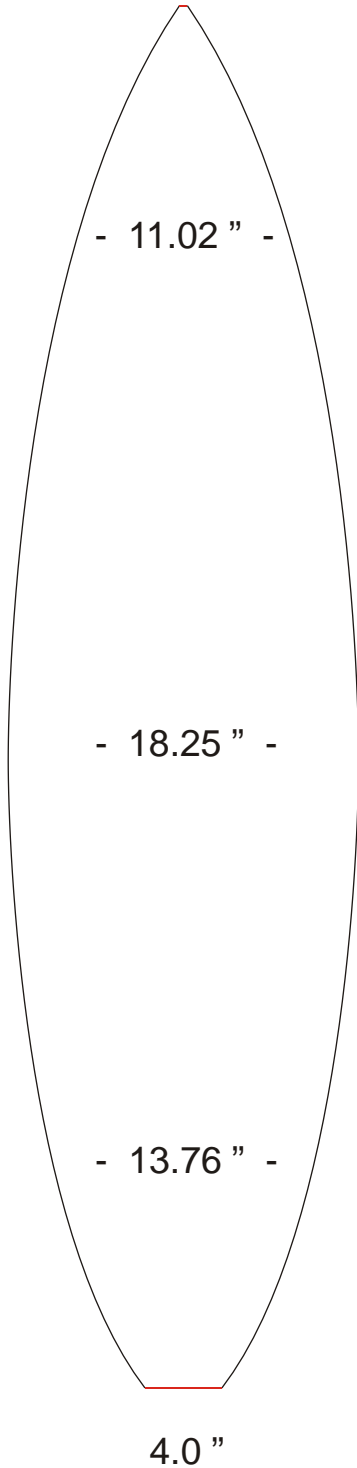

Tip-to-Tip Length : 6 ' 0 "

Maximum Width: 18.25 "

Comments:
SquashTail Series
Maximum width
at 2.30 inches towards tail

Width is measured at 12 " from nose, 12 " from tail and at the widest point.

Square tails and tails cut from square are also measured.

Please note:
All dimensions can be changed for a customized purpose-built blank!



www.sfoam.com

6' 0" TF_t

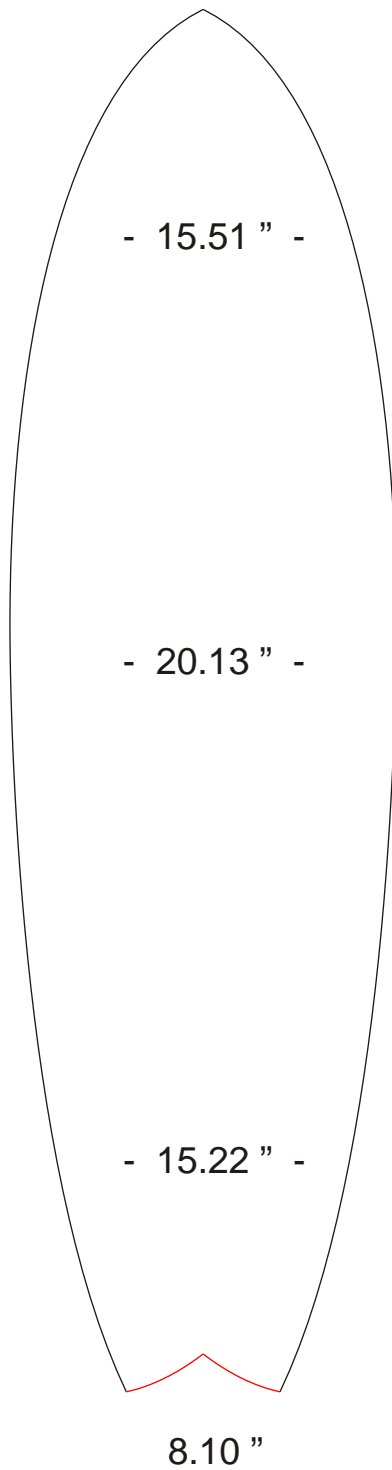

Tip-to-Tip Length : 6 ' 0 "

Maximum Width: 20.13 "

Comments: Maximum width at 4 " towards nose.

Width is measured at 12 " from nose, 12 " from tail and at the widest point.

Square tails and tails cut from square are also measured.

Please note:

All dimensions can be changed for a customized purpose-built blank!



www.sfoam.com

6' 2" F_t

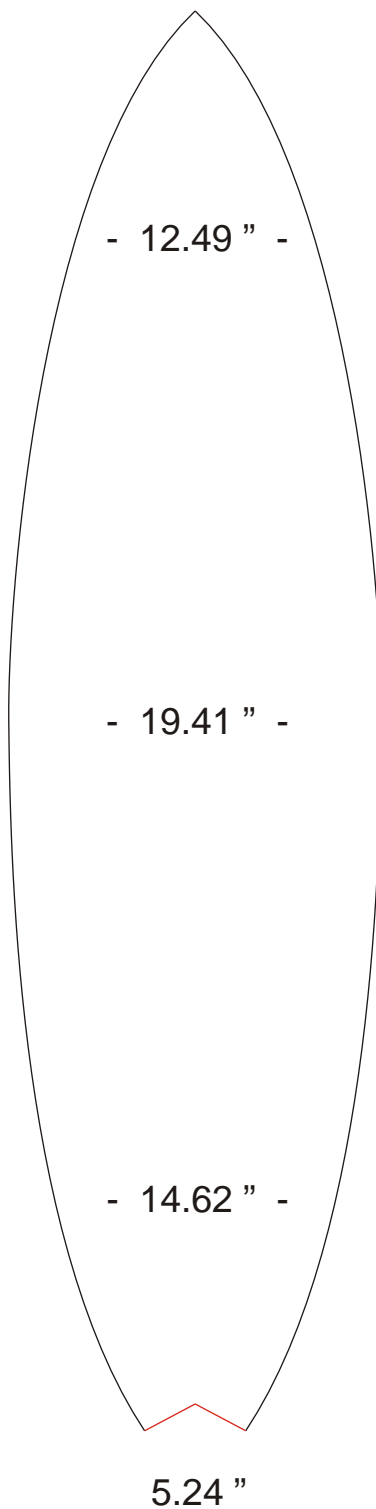

Tip-to-Tip Length : 6 ' 2 "

Maximum Width: 10.41 "

Comments: Modern Fish Thruster. Series 5 ' 10 " to 6 ' 8 " .

Width is measured at 12 " from nose, 12 " from tail and at the widest point.

Square tails and tails cut from square are also measured.

Please note:

All dimensions can be changed for a customized purpose-built blank!



www.sfoam.com

6' 3" RP_t

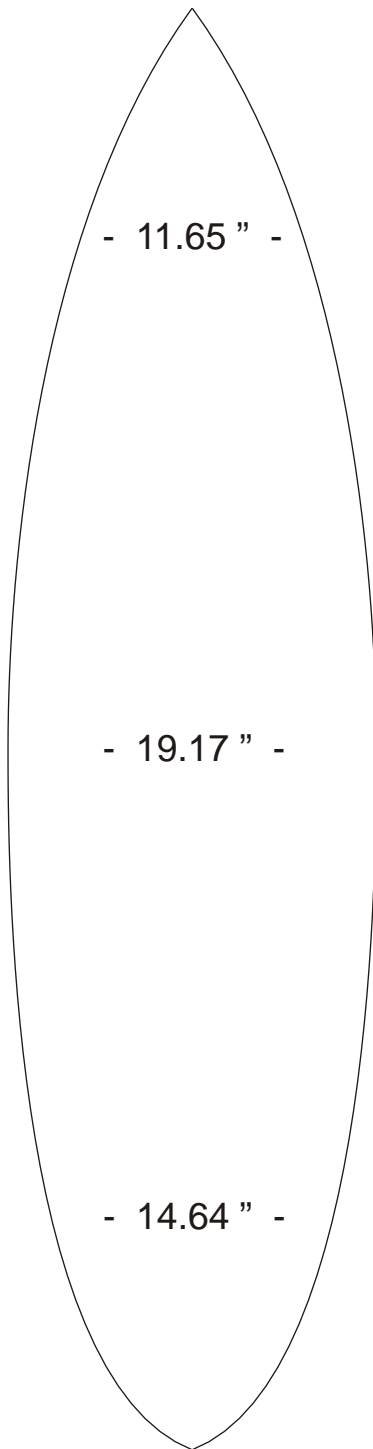

Tip-to-Tip Length : 6 ' 3 "

Maximum Width: 19.17 "

Comments: Maximum width at 1 " towards tail.

Width is measured at 12 " from nose, 12 " from tail and at the widest point.

Square tails and tails cut from square are also measured.

Please note:

All dimensions can be changed for a customized purpose-built blank!

6' 3" S_t

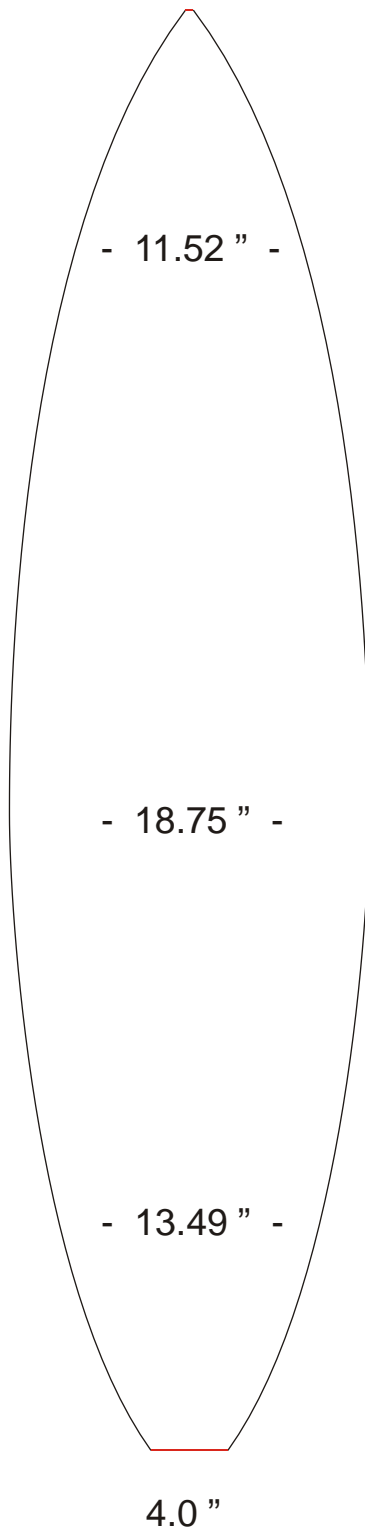

Tip-to-Tip Length : 6 ' 3 "

Maximum Width: 18.75 "

Comments:
Squash Tail Series
Maximum width
at 4.42 " towards tail.

Width is measured at 12 " from nose, 12 " from tail and at the widest point.

Square tails and tails cut from square are also measured.

Please note:

All dimensions can be changed for a customized purpose-built blank!



www.sfoam.com

6' 4" F_t

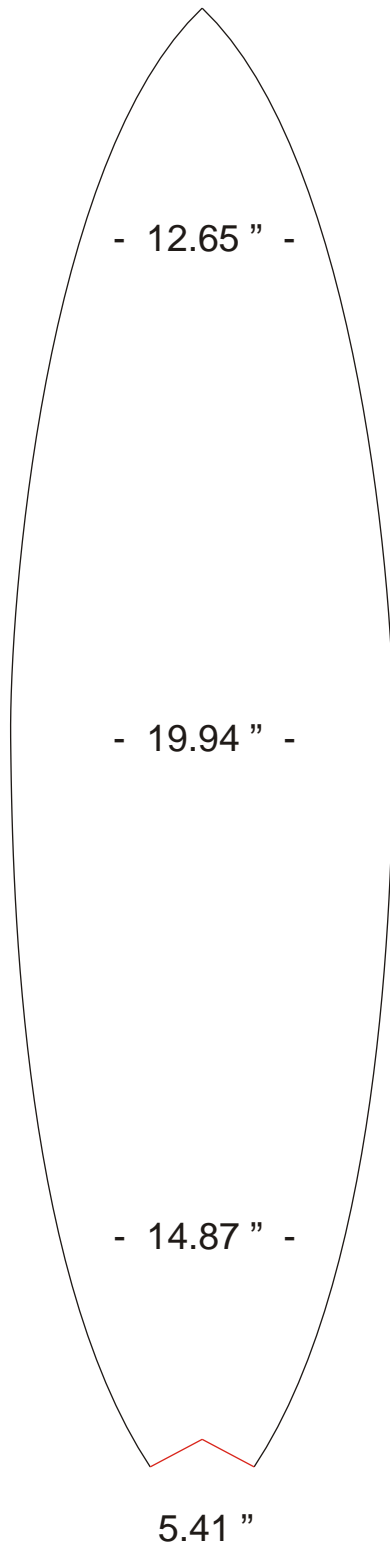

Tip-to-Tip Length : 6 ' 4 "

Maximum Width: 19.94 "

Comments: Modern Fish Thruster. Series 5 ' 10 " to 6 ' 8 " .

Width is measured at 12 " from nose, 12 " from tail and at the widest point.

Square tails and tails cut from square are also measured.

Please note:

All dimensions can be changed for a customized purpose-built blank!



www.sfoam.com

6' 6" F_t

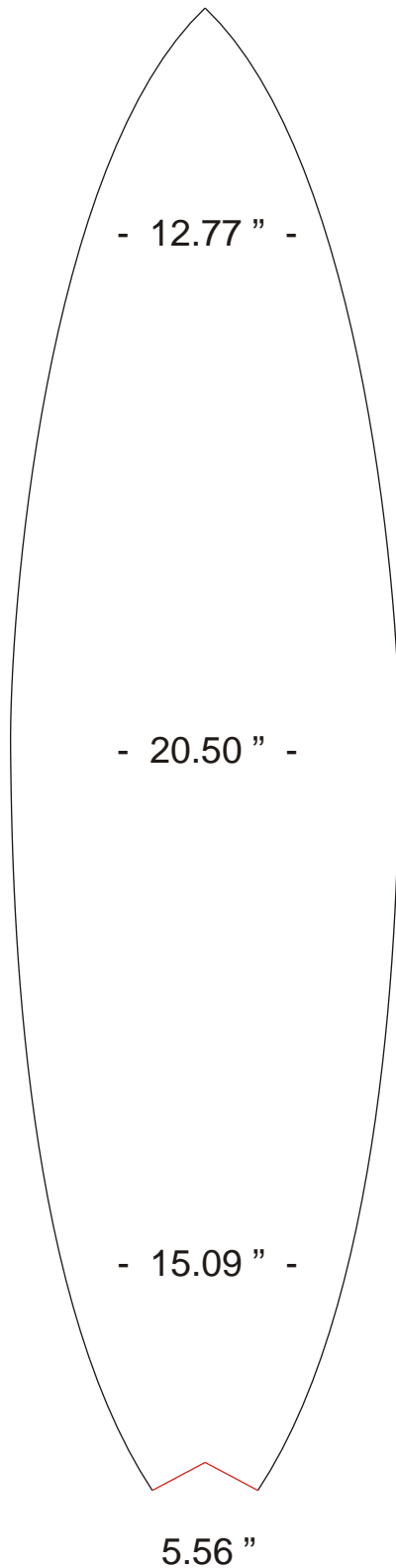

Tip-to-Tip Length : 6 ' 6 "

Maximum Width: 20.5 "

Comments: Modern Fish Thruster. Series 5 ' 10 " thru 6 ' 8 " .

Width is measured at 12 " from nose, 12 " from tail and at the widest point.

Square tails and tails cut from square are also measured.

Please note:

All dimensions can be changed for a customized purpose-built blank!



www.sfoam.com

6' 6" RP_t

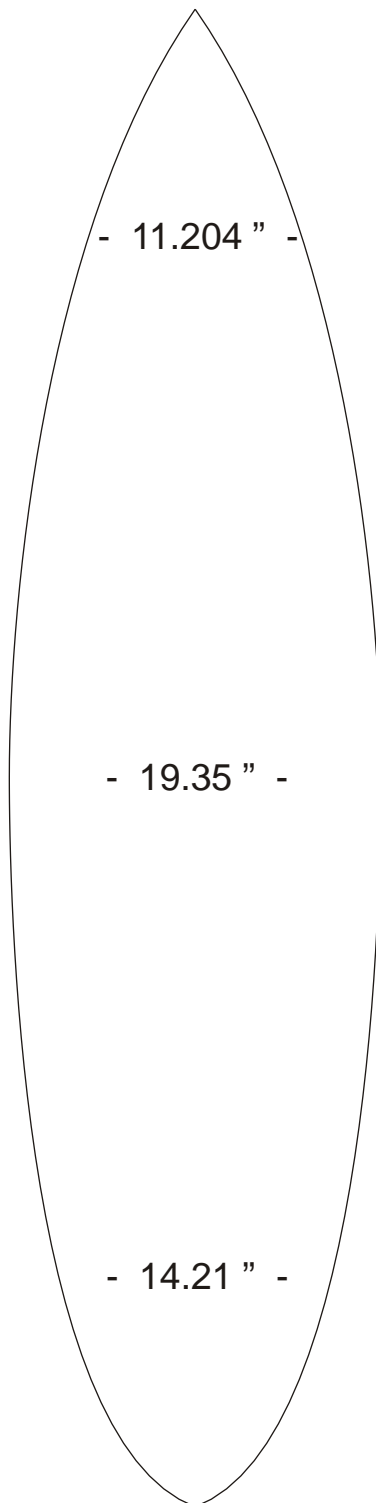

Tip-to-Tip Length : 6 ' 6 "

Maximum Width: 19.35 "

Comments:

Width is measured at 12 " from nose, 12 " from tail and at the widest point.

Square tails and tails cut from square are also measured.

Please note:

All dimensions can be changed for a customized purpose-built blank!



www.sfoam.com

6' 6" S_t

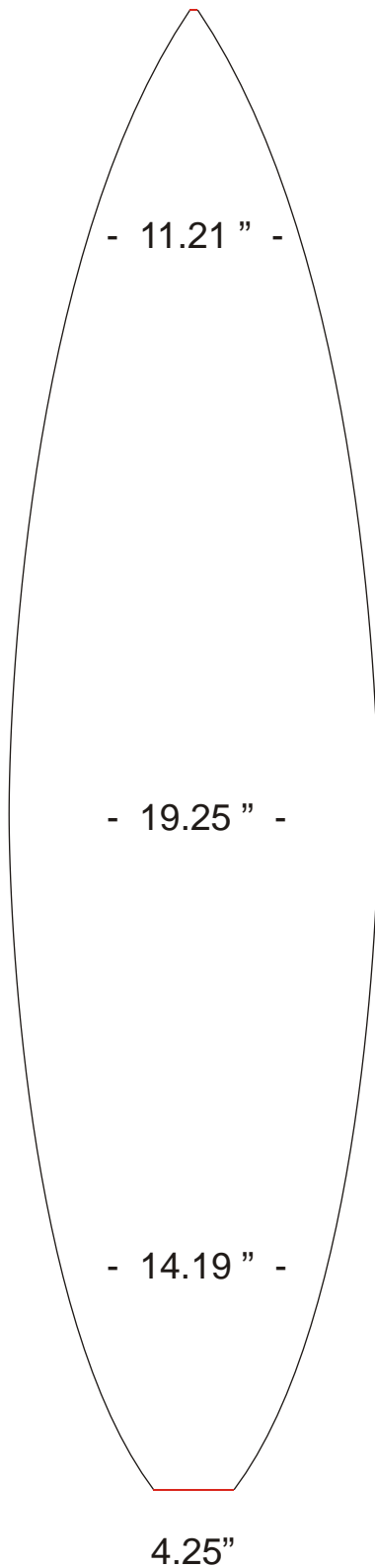

Tip-to-Tip Length :60 ' 6 "

Maximum Width: 19.25 "

Comments:

Squash Tail Series

Maximum width

at 3.51 " toward tail.

Width is measured at 12 " from nose, 12 " from tail and at the widest point.

Square tails and tails cut from square are also measured.

Please note:

All dimensions can be changed for a customized purpose-built blank!



www.sfoam.com

6' 8" F_t

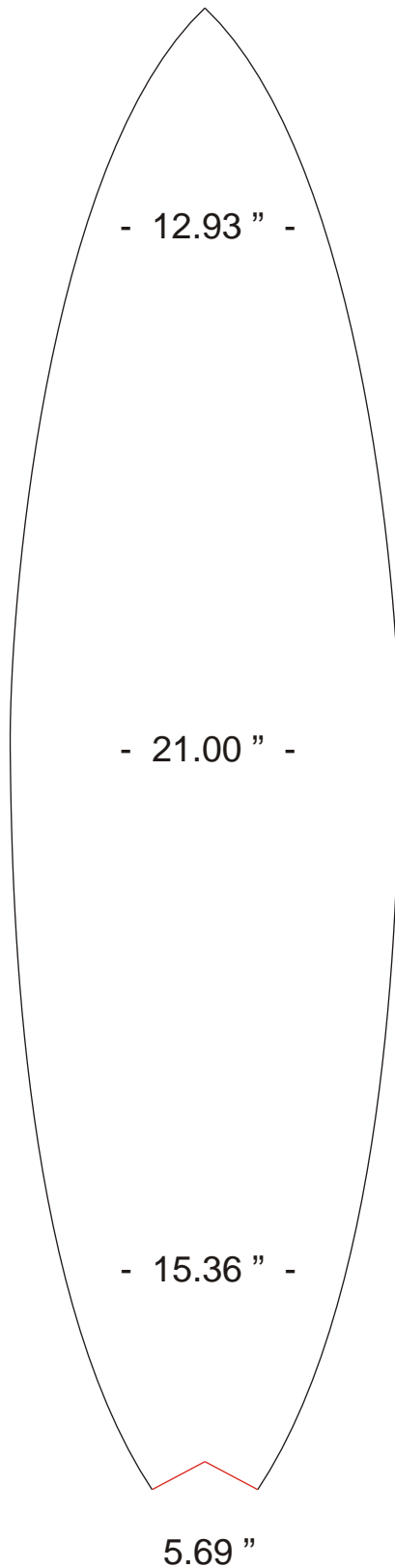

Tip-to-Tip Length : 6 ' 8 "

Maximum Width: 21.00 "

Comments: Modern Fish Thruster. Series 5 ' 10 " to 6 ' 8 " .

Width is measured at 12 " from nose, 12 " from tail and at the widest point.

Square tails and tails cut from square are also measured.

Please note:

All dimensions can be changed for a customized purpose-built blank!

6' 9" S_t

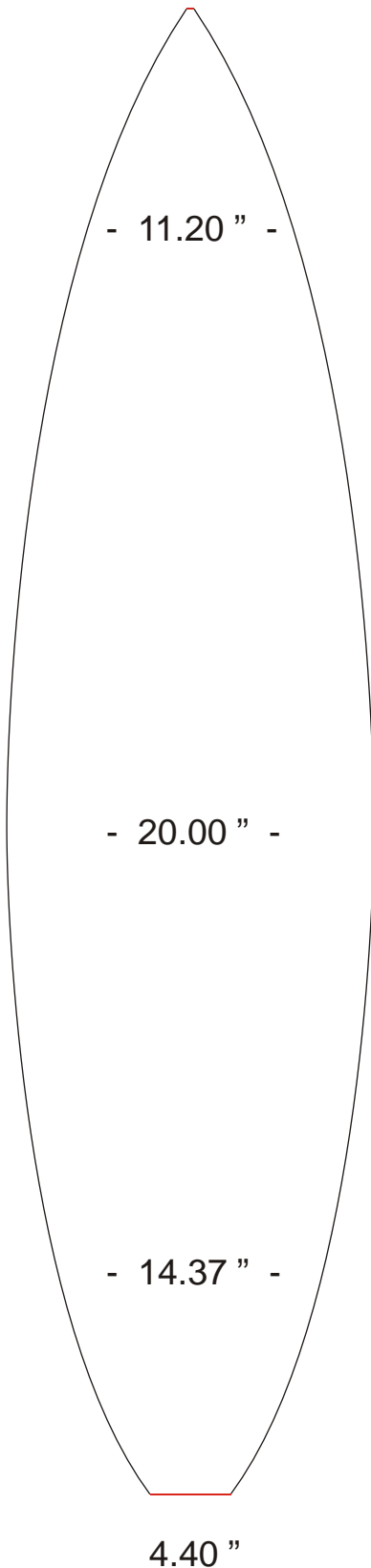

Tip-to-Tip Length : 6 ' 9 "

Maximum Width: 20.00 "

Comments:
Squash Tail Series
Maximum width
at 4.12 " toward tail.

Width is measured at 12 " from nose, 12 " from tail and at the widest point.

Square tails and tails cut from square are also measured.

Please note:

All dimensions can be changed for a customized purpose-built blank!



www.sfoam.com

7' 0" S_t

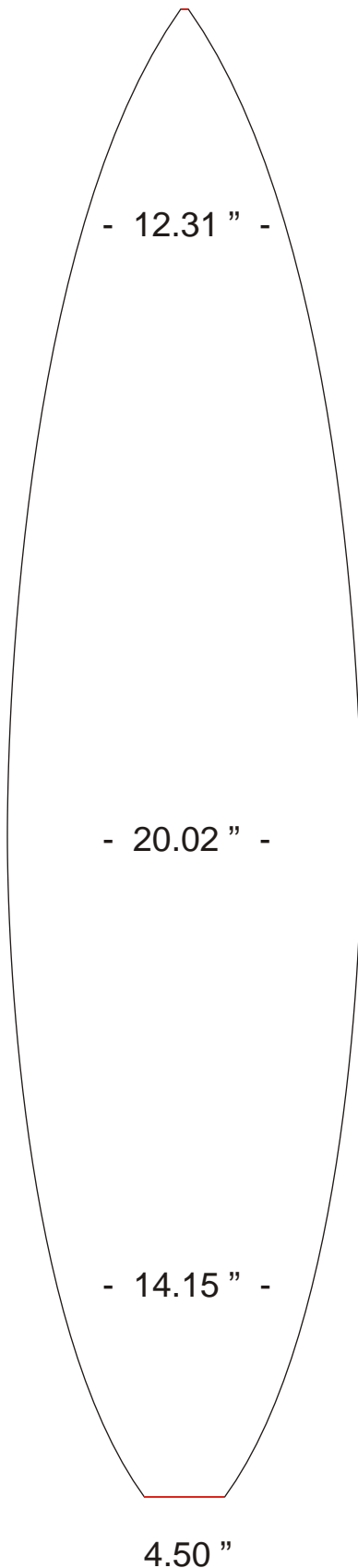

Tip-to-Tip Length : 7 ' 0 "

Maximum Width: 20.02 "

Comments:

Squash Tail Series

Maximum width at 4.72 "
towards tail.

Width is measured at 12 "
from nose, 12 " from tail and
at the widest point.

Square tails and tails cut
from square are also
measured.

Please note:

All dimensions can be
changed for a customized
purpose-built blank!



www.sfoam.com

7' 0" X_t



Tip-to-Tip Length : 7 ' 0 "

Maximum Width: 20.87 "

Comments: " Silverback "
shortboard.

Width is measured at 12 " from nose, 12 " from tail and at the widest point.

Square tails and tails cut from square are also measured.

Please note:

All dimensions can be changed for a customized purpose-built blank!



www.sfoam.com

7' 2"FN_t

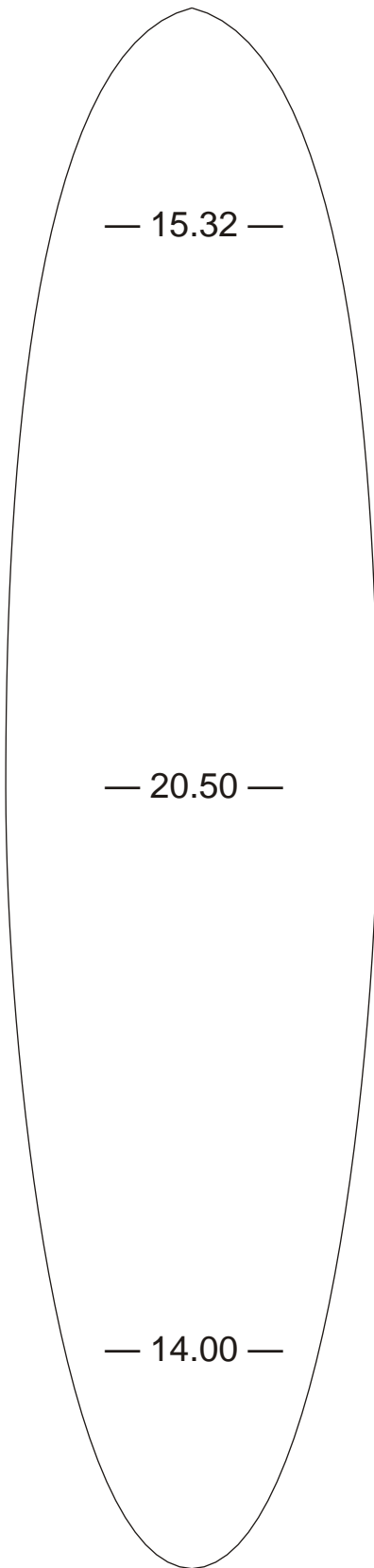

Tip-to-Tip Length : 7 ' 2 "

Maximum Width 20.5 "

Comments:

Fun Egg. Series includes
7 ' 2 " to 7 ' 8 ".

Width is measured at 12 " from nose, 12 " from tail and at the widest point.

Square tails and tails cut from square are also measured.

Please note:

All dimensions can be changed for a customized purpose-built blank!



www.sfoam.com

7' 2" RP_t

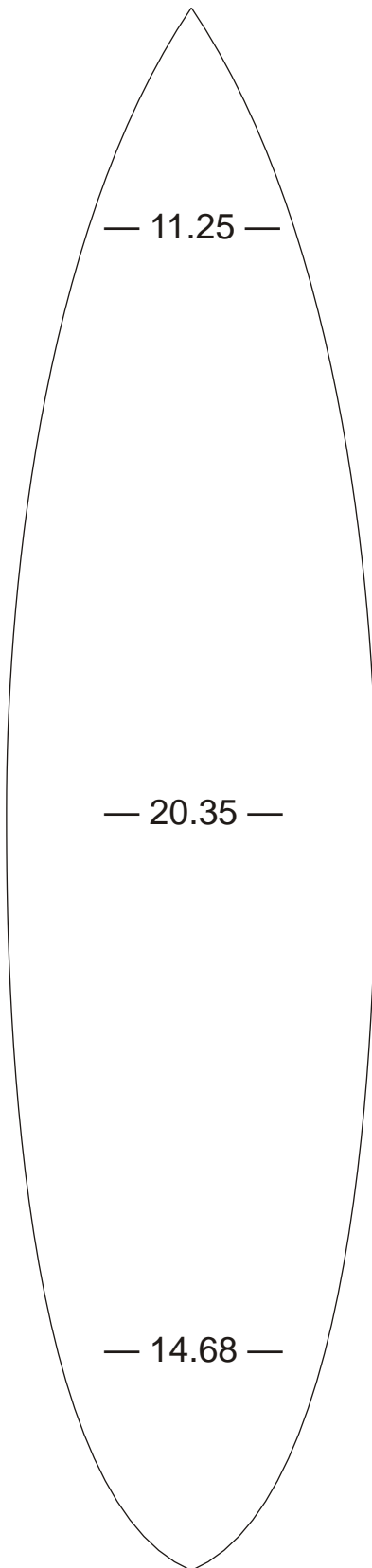

Tip-to-Tip Length : 7 ' 2 "

Maximum Width: 20.35 "

Comments:

Rounded Point. Maximum width at 1.13 inches toward tail. Series includes 6 ' 3 " to 7 ' 2 ".

Width is measured at 12 " from nose, 12 " from tail and at the widest point.

Square tails and tails cut from square are also measured.

Please note:

All dimensions can be changed for a customized purpose-built blank!



www.sfoam.com

7' 2" X_t

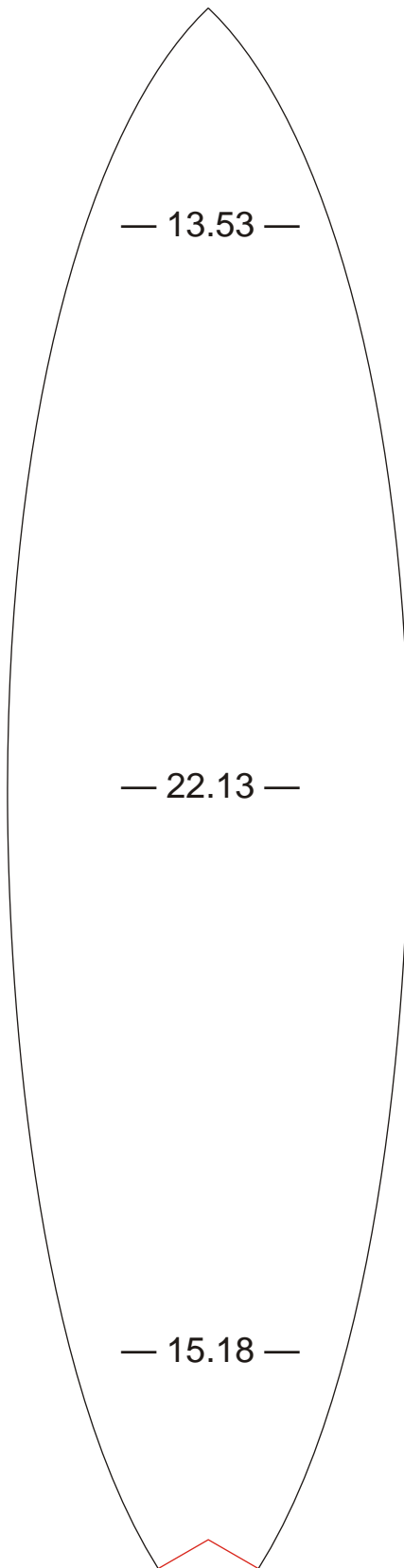

Tip-to-Tip Length : 7 ' 2 "

Maximum Width: 22.13 "

Comments: Texas Fat Fish,
plenty of Flat.

Width is measured at 12 " from nose, 12 " from tail and at the widest point.

Square tails and tails cut from square are also measured.

Please note:

All dimensions can be changed for a customized purpose-built blank!



www.sfoam.com

7' 4" FN_t

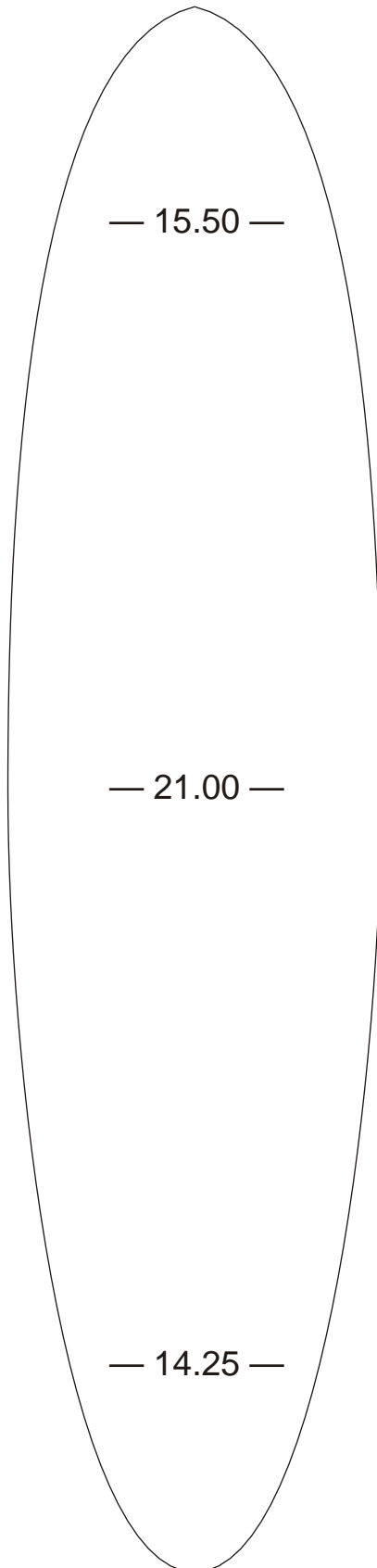

Tip-to-Tip Length : 7 ' 4 "

Maximum Width: 21.00 "

Comments:

Fun Egg. Series includes
7 ' 2 " to 7 ' 8 ".

Width is measured at 12 " from nose, 12 " from tail and at the widest point.

Square tails and tails cut from square are also measured.

Please note:

All dimensions can be changed for a customized purpose-built blank!



www.sfoam.com

7' 4" MG_t

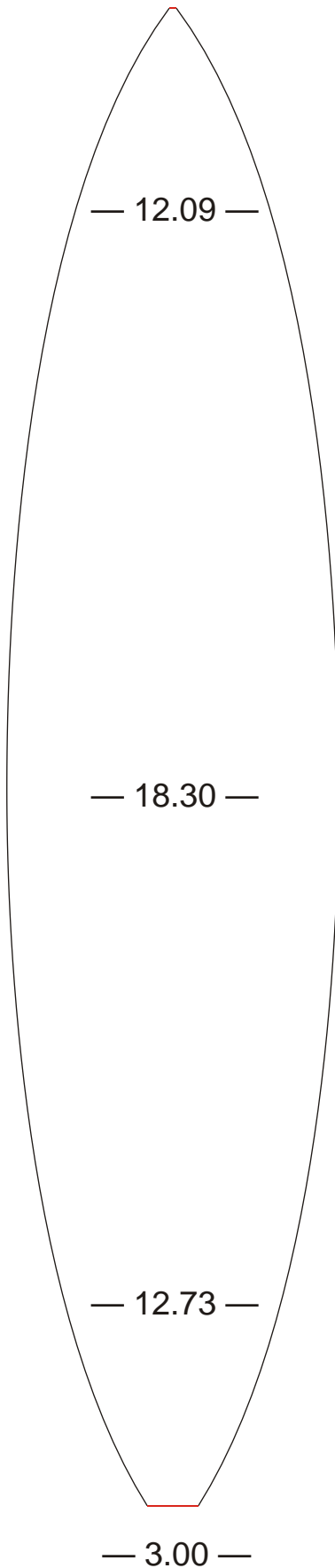

Tip-to-Tip Length : 7 ' 2 "

Maximum Width: 18.30 "

Comments:

Mini Gun

Maximum width at 2.00 inches towards tail.

Width is measured at 12 " from nose, 12 " from tail and at the widest point.

Square tails and tails cut from square are also measured.

Please note:

All dimensions can be changed for a customized purpose-built blank!



www.sfoam.com

7' 6" FN_t

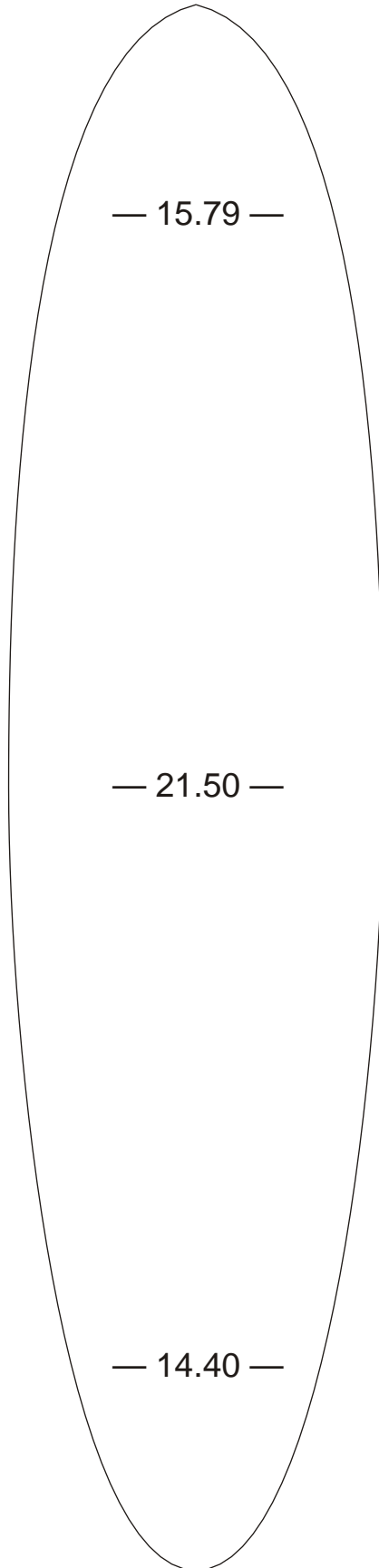

Tip-to-Tip Length : 7 ' 6 "

Maximum Width: 21.5 "

Comments:

Fun Egg. Series includes
7 ' 2 " thru 7 ' 8 "

Width is measured at 12 " from nose, 12 " from tail and at the widest point.

Square tails and tails cut from square are also measured.

Please note:

All dimensions can be changed for a customized purpose-built blank!



www.sfoam.com

7' 6" HY_t

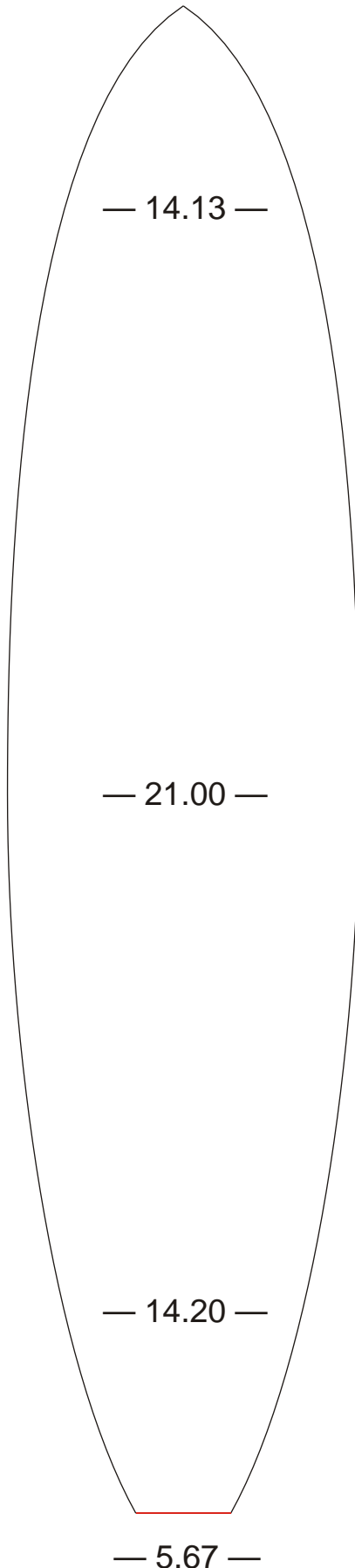

Tip-to-Tip Length : 7 ' 6 "

Maximum Width: 21.00 "

Comments:

Hybrid with narrow nose.
Maximum width at 2.01
inches toward tail.

Width is measured at 12 " from nose, 12 " from tail and at the widest point.

Square tails and tails cut from square are also measured.

Please note:

All dimensions can be changed for a customized purpose-built blank!



www.sfoam.com

7' 6" N_t

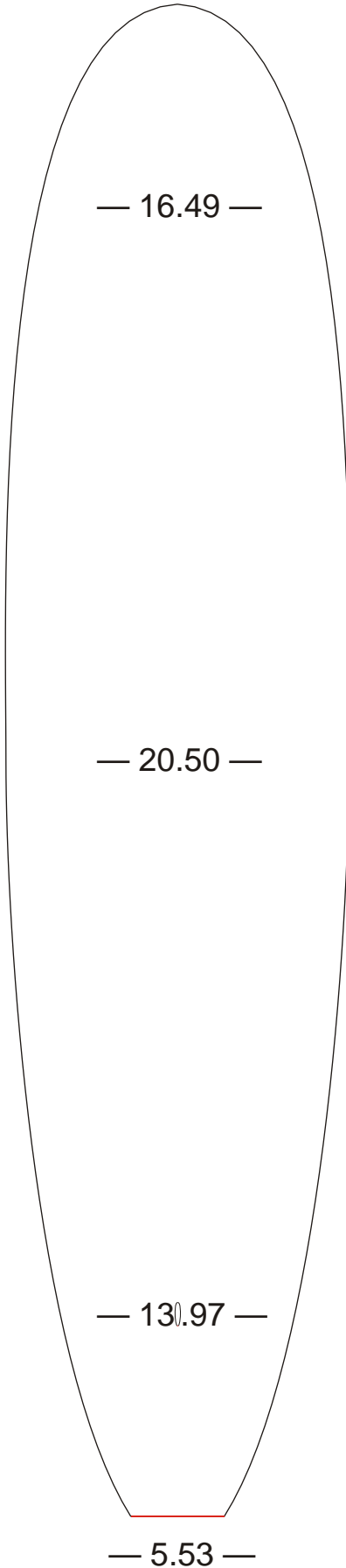

Tip-to-Tip Length : 7 ' 6 "

Maximum Width: 20.5 "

Comments:

Mini Noserider

Width is measured at 12 " from nose, 12 " from tail and at the widest point.

Square tails and tails cut from square are also measured.

Please note:

All dimensions can be changed for a customized purpose-built blank!



www.sfoam.com

7' 6" RP_t

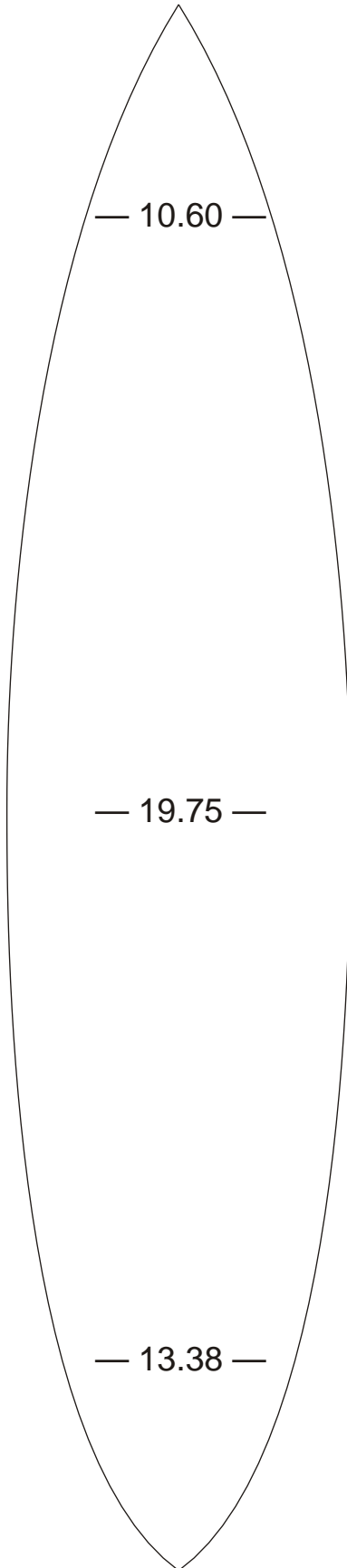

Tip-to-Tip Length : 7 ' 6 "

Maximum Width: 19.75 "

Comments:

Wide point at 1.15 inches towards tail.

Width is measured at 12 " from nose, 12 " from tail and at the widest point.

Square tails and tails cut from square are also measured.

Please note:

All dimensions can be changed for a customized purpose-built blank!



www.sfoam.com

7' 8" FN_t

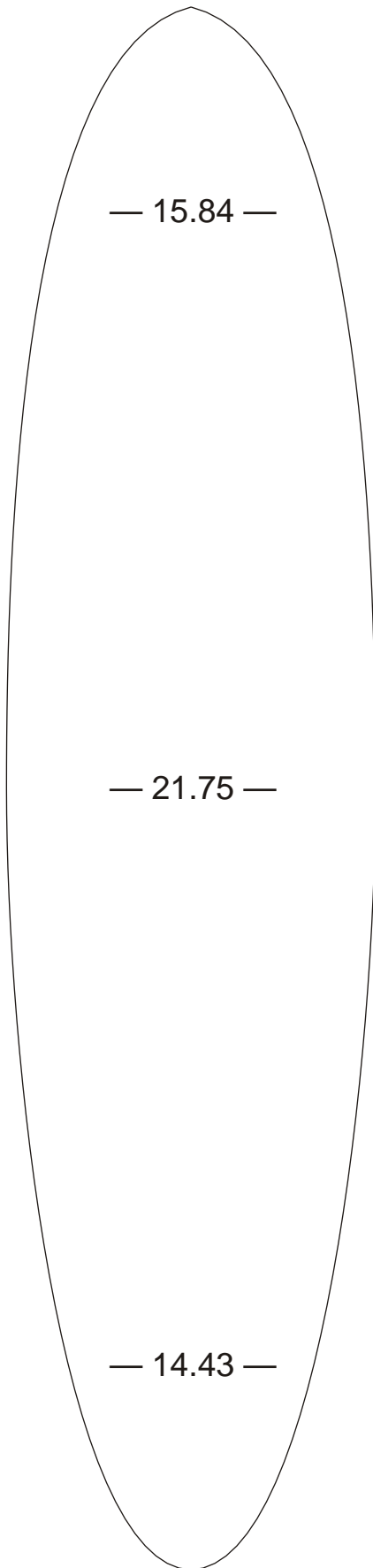

Tip-to-Tip Length : 7 ' 8 "

Maximum Width: 21.75 "

Comments:

Fun Egg. Series includes
7 ' 2 " to 7 ' 8 ".

Width is measured at 12 " from nose, 12 " from tail and at the widest point.

Square tails and tails cut from square are also measured.

Please note:

All dimensions can be changed for a customized purpose-built blank!



www.sfoam.com

8' 0" GN_t

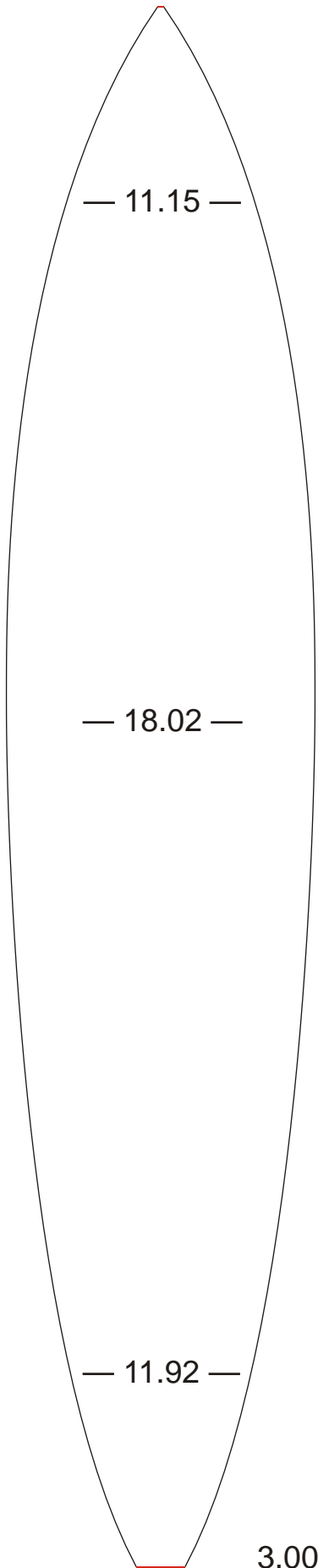

Tip-to-Tip Length : 8 ' 0 "

Maximum Width: 18.024 "

Comments:

Serious Gun

Maximum width at 4 inches toward nose.

Width is measured at 12 " from nose, 12 " from tail and at the widest point.

Square tails and tails cut from square are also measured.

Please note:

All dimensions can be changed for a customized purpose-built blank!



www.sfoam.com

8' 0" HY_t

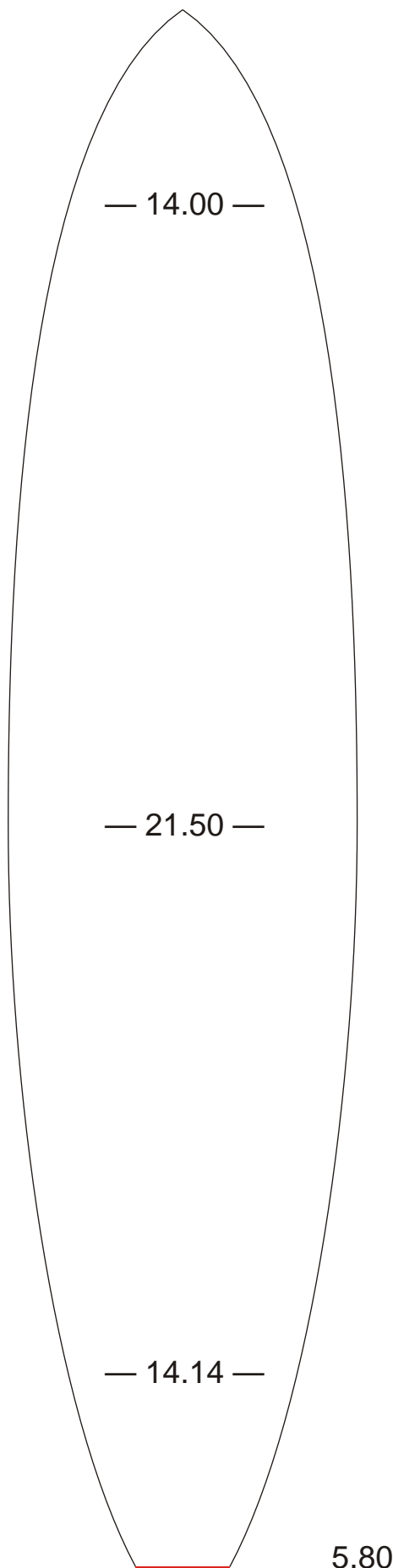

Tip-to-Tip Length : 8 ' 0 "

Maximum Width: 21.50 "

Comments:

Mini Tanker. Maximum width at 2.1 inches toward tail.

Width is measured at 12 " from nose, 12 " from tail and at the widest point.

Square tails and tails cut from square are also measured.

Please note:

All dimensions can be changed for a customized purpose-built blank!



www.sfoam.com

8' 0" N_t

Tip-to-Tip Length : 8 ' 0 "

Maximum Width: 21.20 "

Comments:

Mini Noserider

Width is measured at 12 " from nose, 12 " from tail and at the widest point.

Square tails and tails cut from square are also measured.

Please note:

All dimensions can be changed for a customized purpose-built blank!

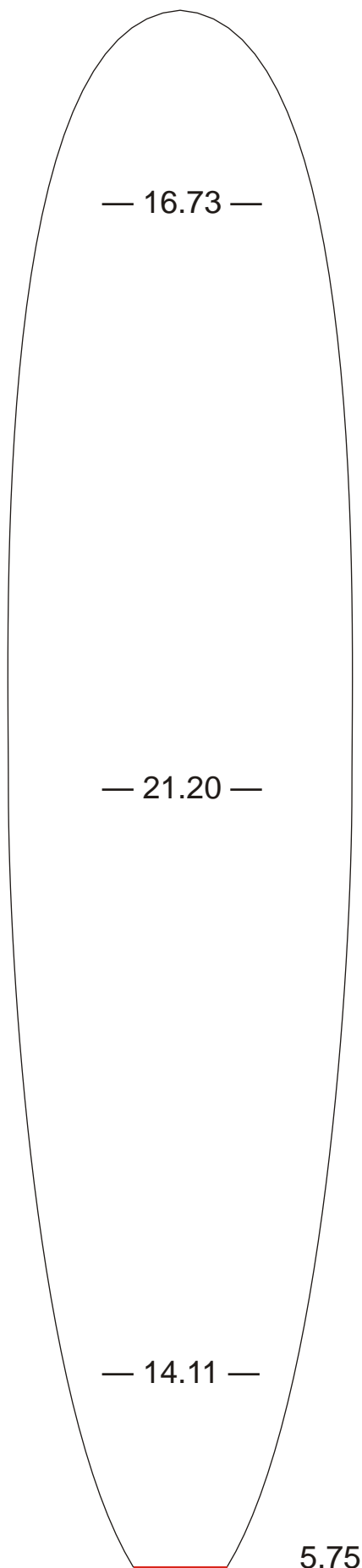



www.sfoam.com

8' 0" PL_t

Tip-to-Tip Length : 8 ' 0 "

Maximum Width: 21.46 "

Comments:

Performance longboard.
Maximum width at 5.3 inches
from center towards nose.
Series 8' 0" to 9' 6"

Width is measured at 12 " from nose, 12 " from tail and at the widest point.

Square tails and tails cut from square are also measured.

Please note:

All dimensions can be changed for a customized purpose-built blank!

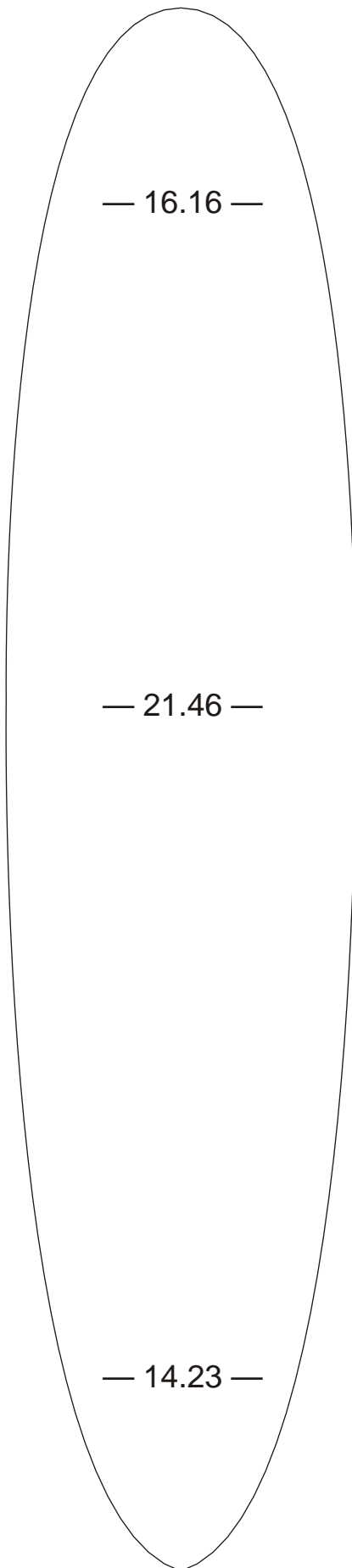



www.sfoam.com

8' 6" N_t

Tip-to-Tip Length : 8 ' 6 "

Maximum Width: 22.25 "

Comments:

Classic nose rider. Series
8' 6" to 10'

Width is measured at 12 " from nose, 12 " from tail and at the widest point.

Square tails and tails cut from square are also measured.

Please note:

All dimensions can be changed for a customized purpose-built blank!

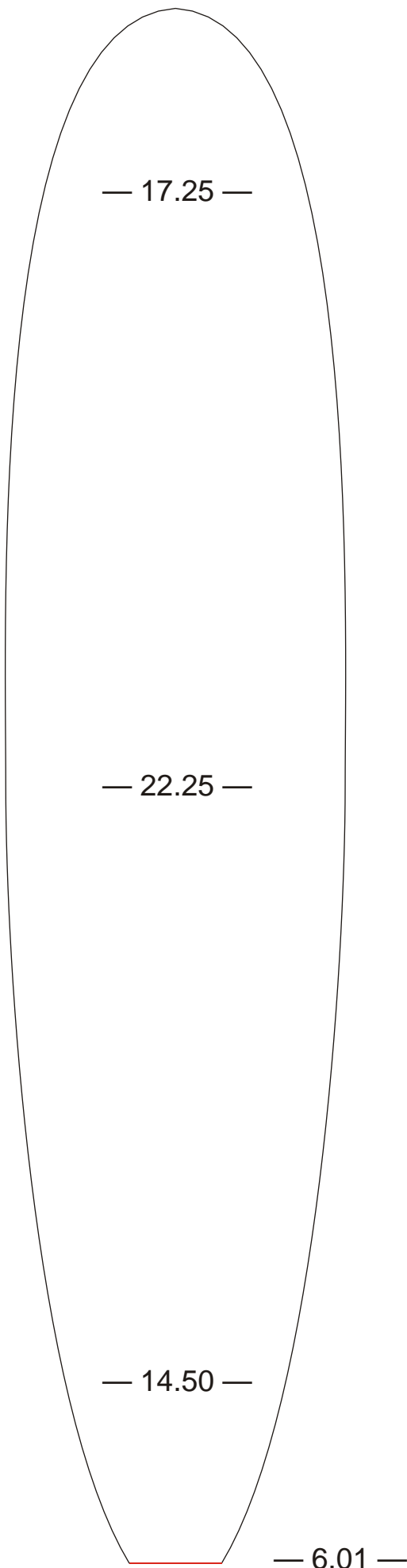



www.sfoam.com

8' 6" PL_t

Tip-to-Tip Length : 8 ' 6 "

Maximum Width: 21.74 "

Comments:

Performance long board.

Maximum width at 5.6 inches
from center towards nose.

Series 8' 0" to 9' 6".

Width is measured at 12 "
from nose, 12 " from tail and
at the widest point.

Square tails and tails cut
from square are also
measured.

Please note:

All dimensions can be
changed for a customized
purpose-built blank!

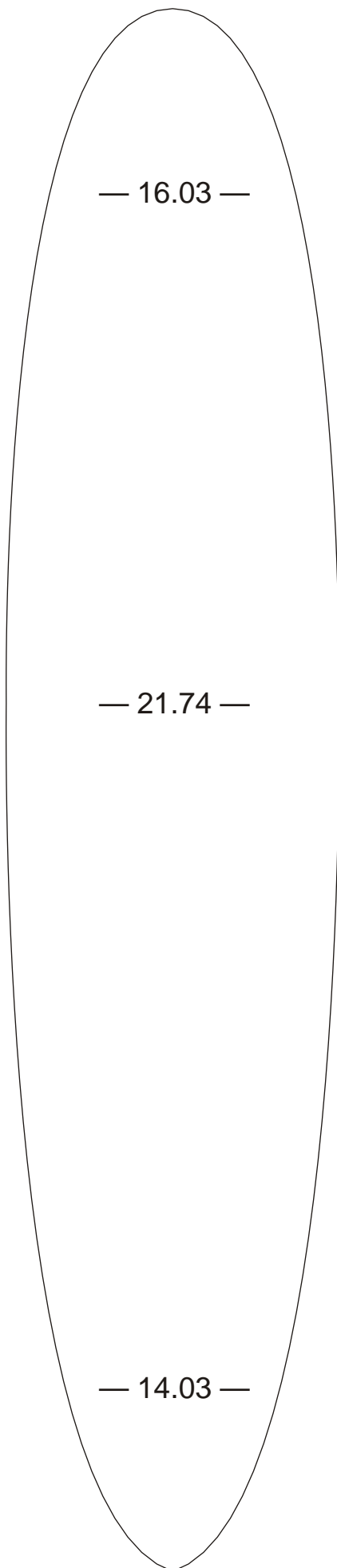



www.sfoam.com

8' 11" X1_t

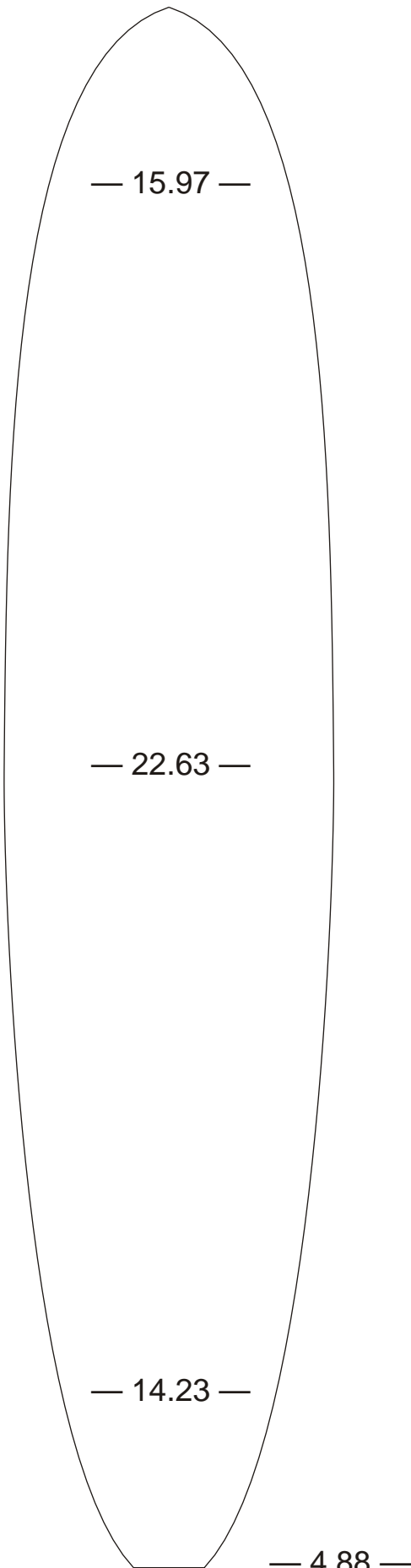

Tip-to-Tip Length : 8 ' 11 "

Maximum Width: 22.63 "

Comments:

Wave catcher, forward trim,
performance long board.
Maximum width 1 inch
forward of center.

Width is measured at 12 " from nose, 12 " from tail and at the widest point.

Square tails and tails cut from square are also measured.

Please note:

All dimensions can be changed for a customized purpose-built blank!



www.sfoam.com

9' 0" GN_t

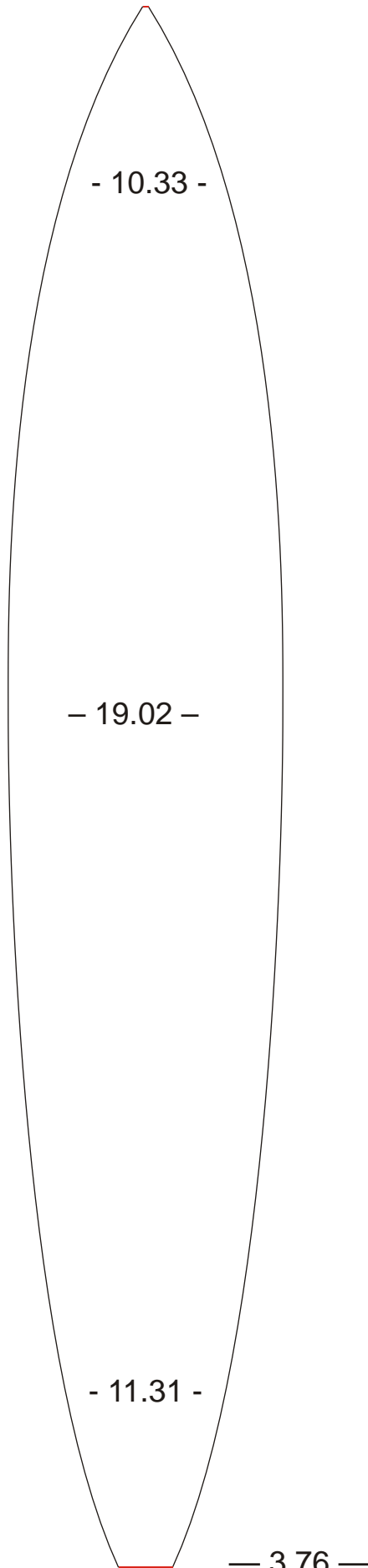

Tip-to-Tip Length : 9 ' 0 "

Maximum Width: 19.02 "

Comments:

Serious Gun

Maximum width at 5 inches towards nose.

Width is measured at 12 " from nose, 12 " from tail and at the widest point.

Square tails and tails cut from square are also measured.

Please note:

All dimensions can be changed for a customized purpose-built blank!



www.sfoam.com

9' 0" N_t

Tip-to-Tip Length : 9 ' 0 "

Maximum Width: 22.00 "

Comments:

Classic nose rider. Series
7' 6" to 10'.

Width is measured at 12 " from nose, 12 " from tail and at the widest point.

Square tails and tails cut from square are also measured.

Please note:

All dimensions can be changed for a customized purpose-built blank!

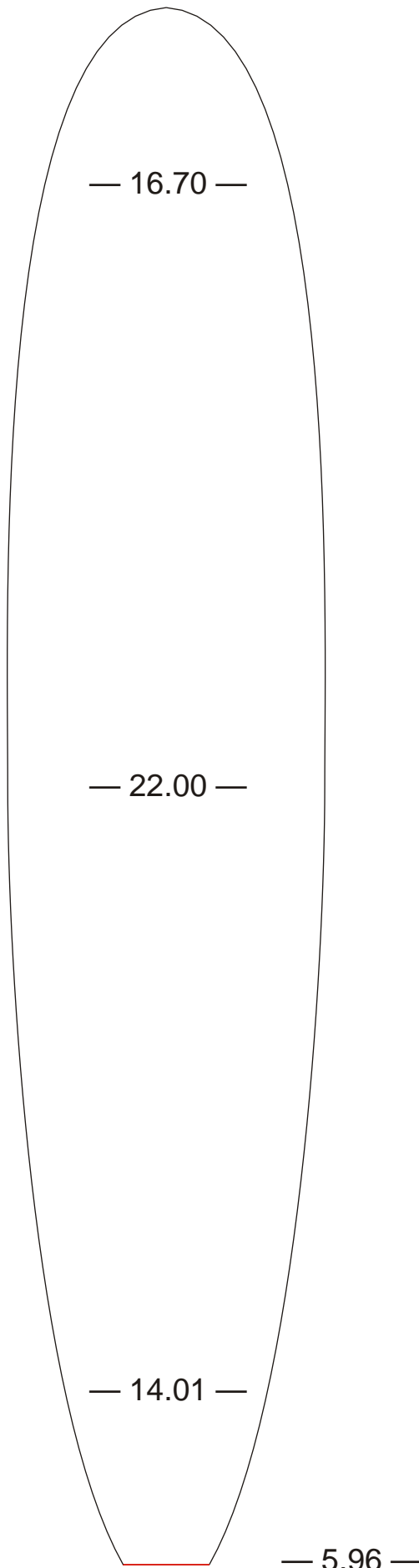



www.sfoam.com

9' 0" NW_t

Tip-to-Tip Length : 9 ' 0 "

Maximum Width: 22.38 "

Comments

"Double Wide" nose rider.:

Width is measured at 12 " from nose, 12 " from tail and at the widest point.

Square tails and tails cut from square are also measured.

Please note:

All dimensions can be changed for a customized purpose-built blank!

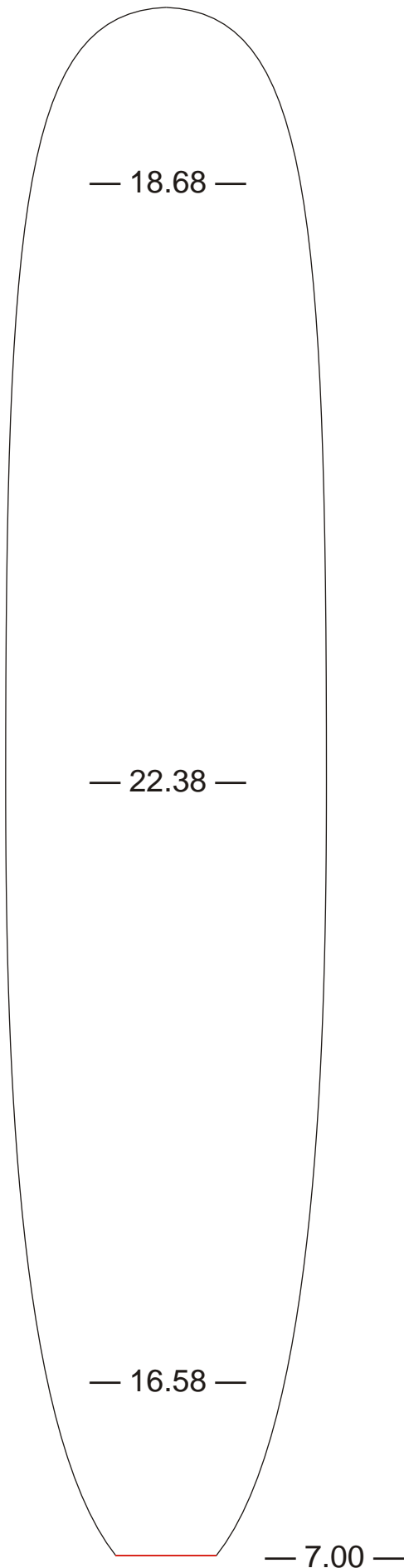



www.sfoam.com

9' 0" PL_t

Tip-to-Tip Length : 9 ' 0 "

Maximum Width: 22.00 "

Comments:

Performance long board.
Maximum width at 6 inches
from center toward nose.
Series 8' to 9' 6".

Width is measured at 12 " from nose, 12 " from tail and at the widest point.

Square tails and tails cut from square are also measured.

Please note:

All dimensions can be changed for a customized purpose-built blank!

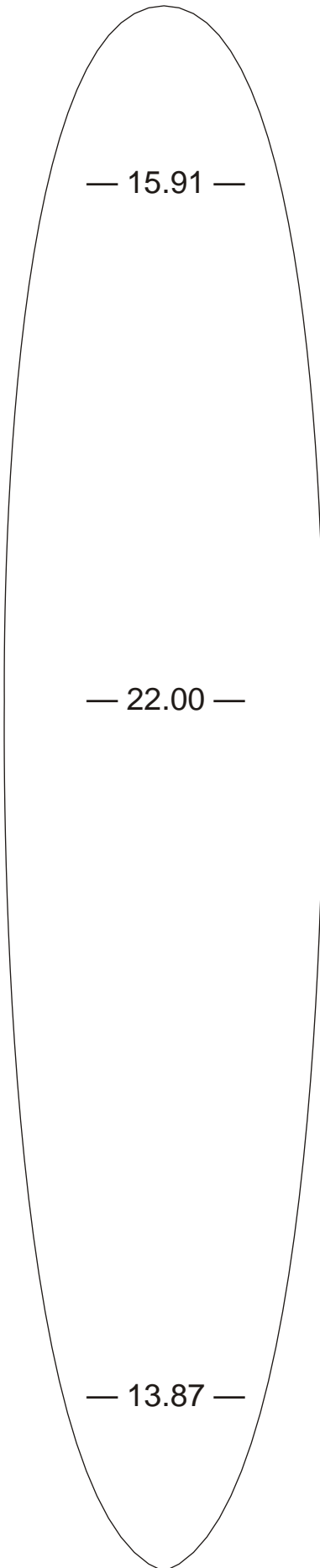



www.sfoam.com

9' 6" N_t

Tip-to-Tip Length : 9 ' 6 "

Maximum Width: 22.50 "

Comments:

Classic nose rider. Series
8' 6" to 10'.

Width is measured at 12 " from nose, 12 " from tail and at the widest point.

Square tails and tails cut from square are also measured.

Please note:

All dimensions can be changed for a customized purpose-built blank!

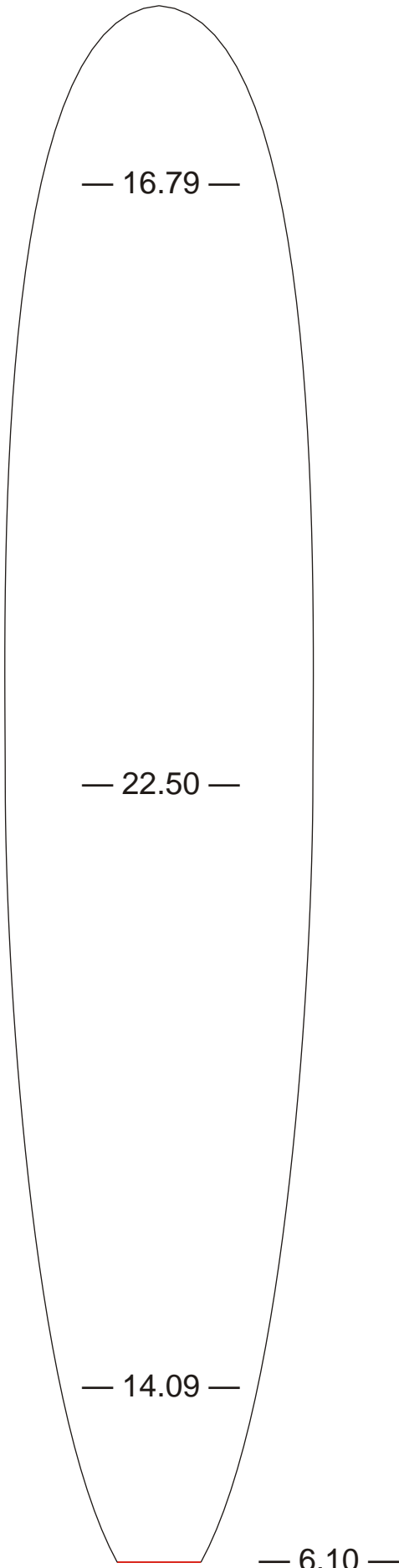



www.sfoam.com

9' 6" NW_t

Tip-to-Tip Length : 9 ' 6 "

Maximum Width: 22.50 "

Comments:

"Double Wide" nose rider.

Width is measured at 12 " from nose, 12 " from tail and at the widest point.

Square tails and tails cut from square are also measured.

Please note:

All dimensions can be changed for a customized purpose-built blank!

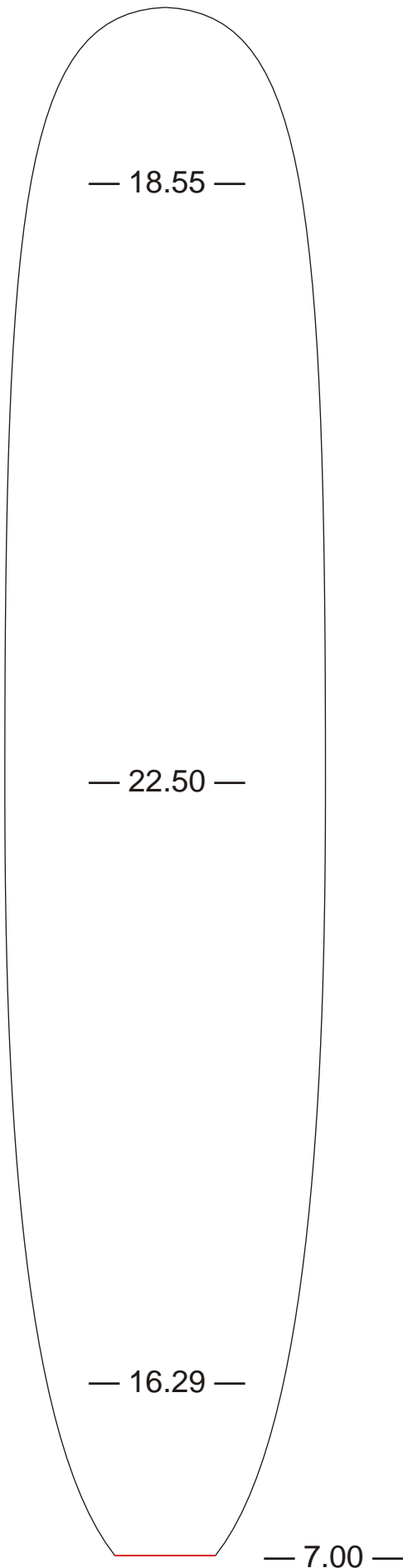



www.sfoam.com

9' 6" PL_t

Tip-to-Tip Length : 9 ' 6 "

Maximum Width: 22.50 "

Comments:

Performance long board.
Maximum width at 6.3 inches
from center toward nose.

Width is measured at 12 " from nose, 12 " from tail and at the widest point.

Square tails and tails cut from square are also measured.

Please note:

All dimensions can be changed for a customized purpose-built blank!

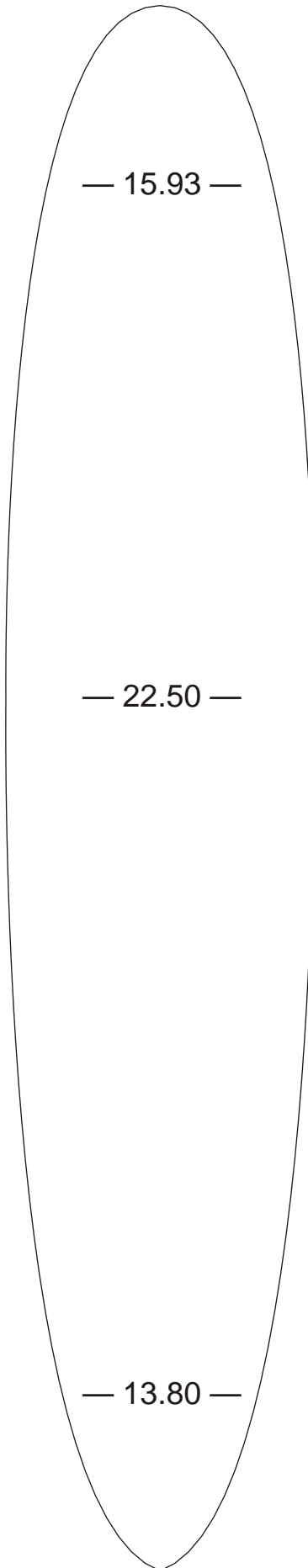



www.sfoam.com

10' 0" N_t

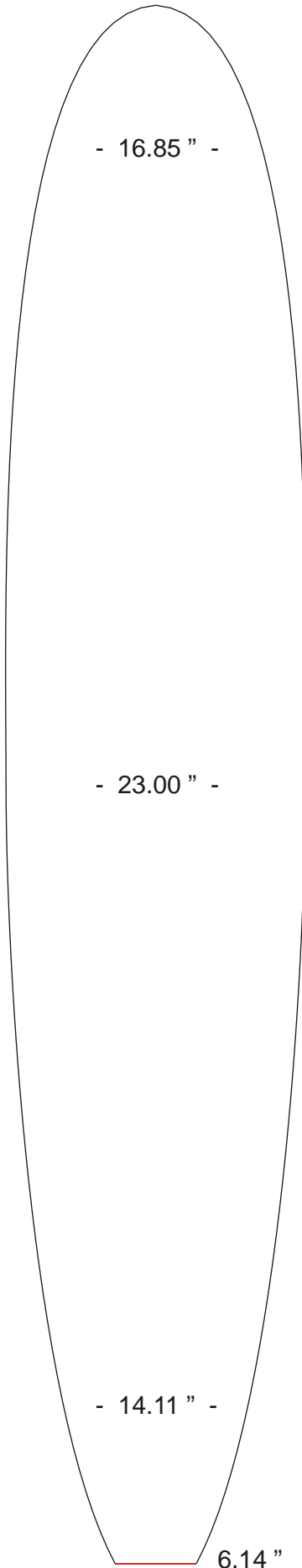

Tip-to-Tip Length : 10 ' 0 "

Maximum Thickness: 23.0 "

Comments: Classic Nose-rider. Series 7 ' 6 " to 10 ' 6 " .

Width is measured at 12 " from nose, 12 " from tail and at the widest point.

Square tails and tails cut from square are also measured.

Please note:

All dimensions can be changed for a customized purpose-built blank!



www.sfoam.com

10' 0" NW_t

Tip-to-Tip Length : 10 ' 0 "

Maximum Width: 23.00 "

Comments:

"Double Wide" nose rider.

Width is measured at 12 " from nose, 12 " from tail and at the widest point.

Square tails and tails cut from square are also measured.

Please note:

All dimensions can be changed for a customized purpose-built blank!

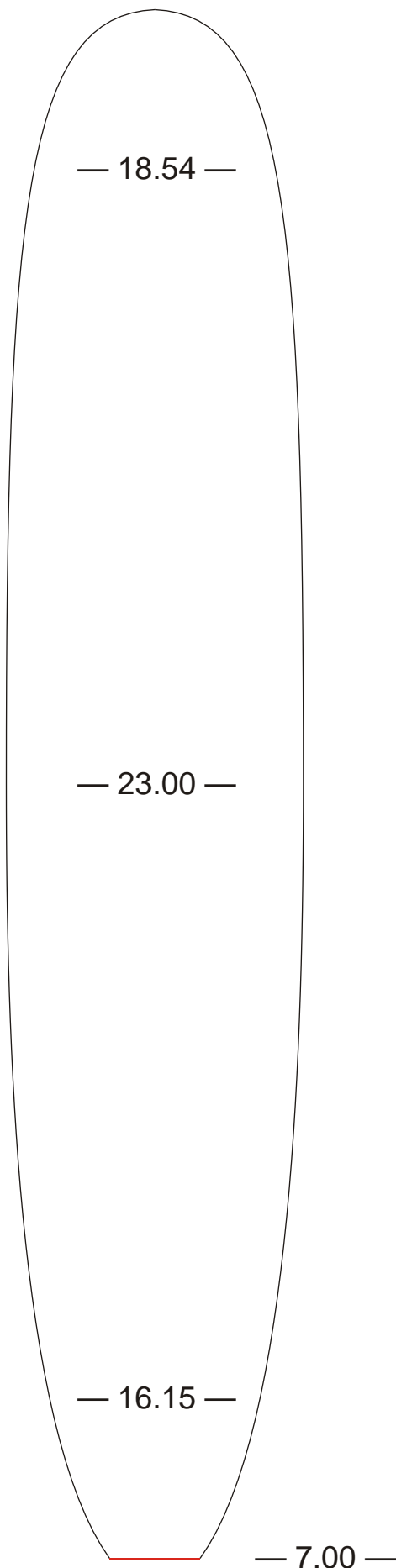



www.sfoam.com

10' 6" N_t

Tip-to-Tip Length : 10 '6 "

Maximum Width: 24.00 "

Comments:

Classic nose rider for the big guy.

Width is measured at 12 " from nose, 12 " from tail and at the widest point.

Square tails and tails cut from square are also measured.

Please note:

All dimensions can be changed for a customized purpose-built blank!

Copyright by sFoam 2004

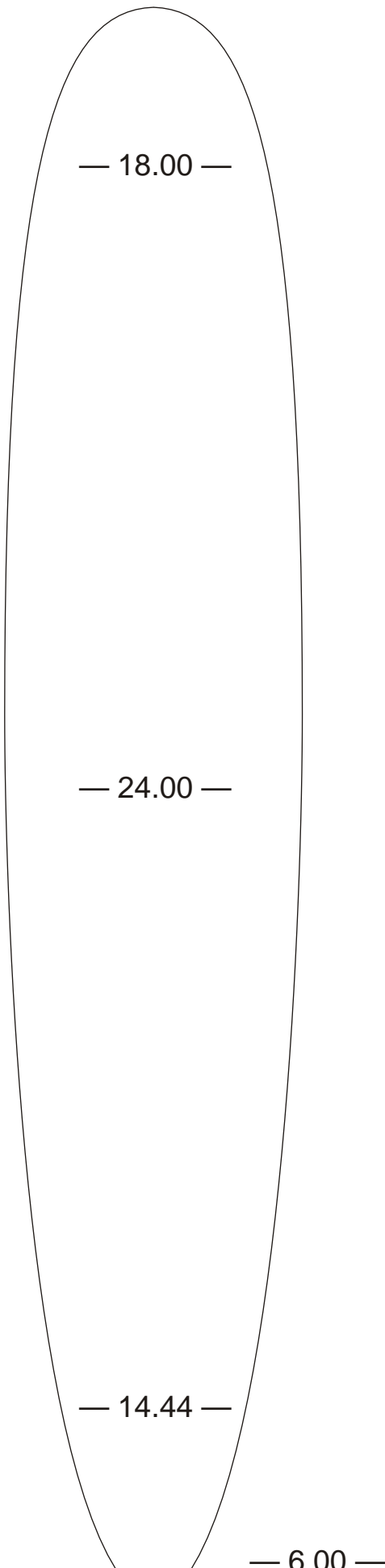



www.sfoam.com

End of Catalog
Please check www.sFoam.com
for latest blank styles.

